



fischer 

**Catálogo
Brocas
2019/2020**





Quando a qualidade e a inovação se encontram

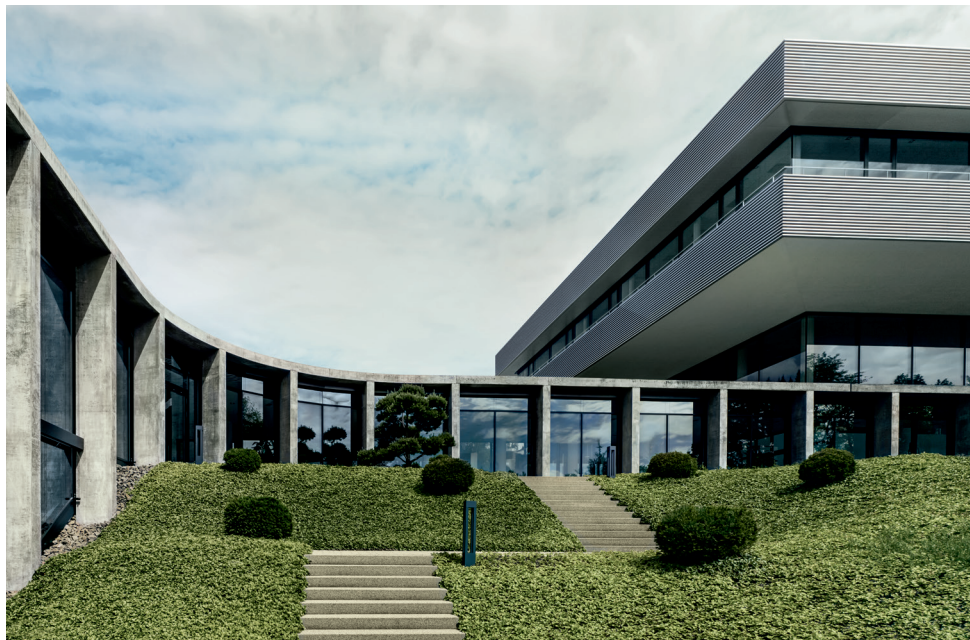

Gama de Brocas

Gama



Materiais

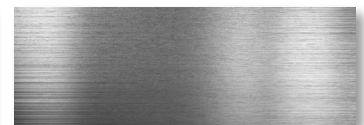

Aplicações



SDS

QUATTRIC II



POINTER



POINTER M



MAX II e IV



FHD



CINZÉIS FCP

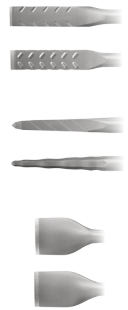

Gama de Brocas

Gama



Materiais

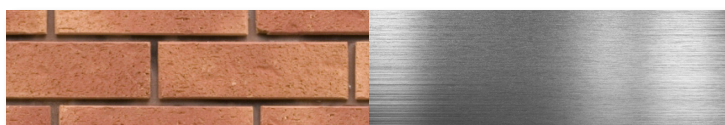



Aplicações





Índice

Percussão

SUPER		10
EXTRA		11
QUATRIUM		12







Madeira

HB		14
PALA		15



Metal

HSS		16
HSS-Co		17

SDS

QUATTRIC II		18
POINTER		20
POINTER M		21
MAX II / MAX IV		22
FHD		23
CINZÉIS FCP		24

Cerâmica

ULTIMATE		25
D-GT		26
DIAMANTE		27

Coroas

MULTIMATERIAL		28
METAL		30



Legenda

- PEDRA
- BETÃO
- MADEIRA

- METAL HSS
- METAL HSS-Co

- SDS
- CRISTAL/
CERÂMICA

Broca SUPER D-S

Percussão

Broca **universal** para perfurações rotativas ou de impacto em **alvenaria e pedra natural**

Ponta de carbono reforçada de 130°
para uma vida duradoura e resistente
à temperatura

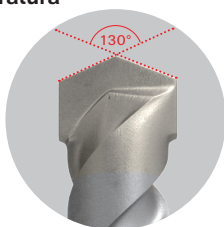

Laminado segundo a
norma DIN 8039

Adaptável para perfuração
rotativa ou com percussão



Ótima extração da poeira
devido à geometria
da espiral



Alvenaria oca

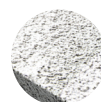

Betão celular



Pedra

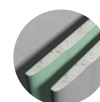

Placa de gesso
cartonado

DIN
8039

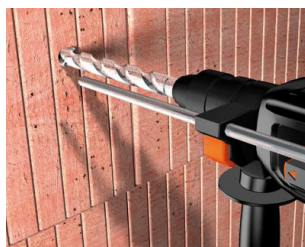

Broca EXTRA D-C

Percussão

Broca para **betão** com **ponta de carbono**

Ponta de carbono de 130° para uma maior durabilidade, extremamente resistente à temperatura

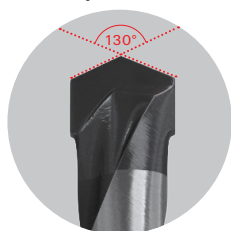

Laminado segundo a norma DIN 8039

Oferece robustez e é muito resistente à quebra

Adequada para perfurações rotativas e com percussão



Ótima extração da poeira devido à geometria da sua espiral

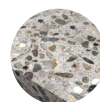

Betão



Alvenaria oca

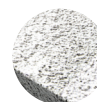

Betão celular



Pedra

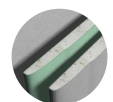

Placa de gesso cartonado

DIN 8039



Broca QUATRIUM D-SDX

Percussão

A melhor broca para alvenaria com 4 pontas

Ponta de carbono reforçada de 130°
para uma vida duradoura e resistente
à temperatura

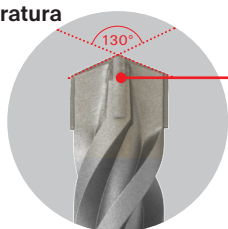

Broca de 4 pontas
para melhorar o desempenho
na perfuração

O design da espiral 4x4
minimiza o desgaste e o atrito
transmitindo uma baixa
vibração e facilitando a sua
utilização

Ponta de centrar que
facilita o posicionamento e
impede que deslize

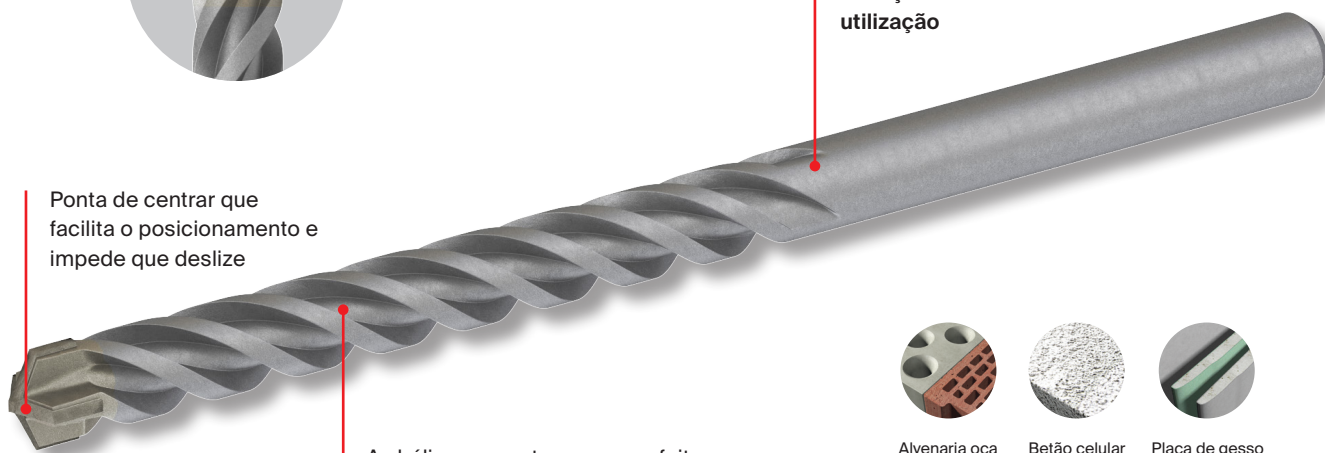

As hélices garantem uma perfeita
extração da poeira e evitam o
aquecimento e desgaste da broca



Alvenaria oca

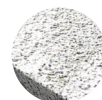

Betão celular

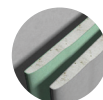

Placa de gesso
cartonado

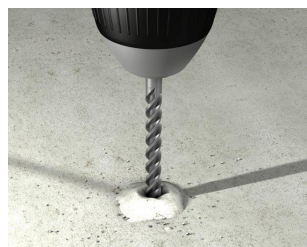



X4
PUNTAS

QUA X TRIUM

**A broca mais
revolucionária
do mercado**

Broca HB D-WS

Madeira

Broca de madeira com ponta de centrar

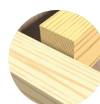

Madeira

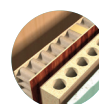

Materiais ocos



Plástico

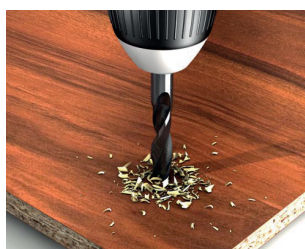

Broca PALA D-WF

Madeira

Broca de madeira com ponta muito afiada

Ponta de centrar muito afiada

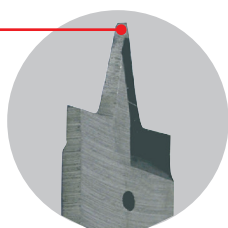

Oferece robustez e é muito resistente à quebra

Forjado segundo DIN 7487



Ponta especial com duas arestas para uma perfuração limpa e sem abrasivo

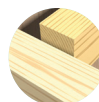

Madeira

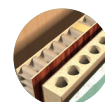

Materiais ocos

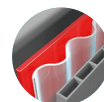

Plástico

DIN 7487



Broca HSS D-HSS-R

Metal

Broca de metal de alto rendimento

Ângulo de inclinação 118° para melhorar a refrigeração e a precisão

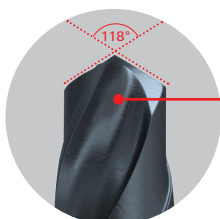

Cinzel com reforços entorpecidos para as forças laterais

Fabricada em aço robusto HSS

Forjado segundo DIN 338

Broca robusta com grande resistência a quebrar

Ótima extração de aparas devido à espiral em forma N

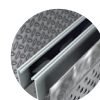

Metal

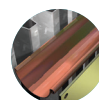

Outros materiais

DIN 338



118°



Broca HSS-Co D-HSS-Co Metal

Broca de metal de alta precisão

Ângulo de 135° para uma perfuração rápida

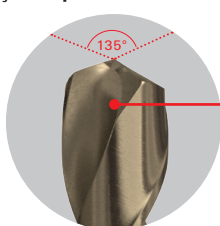

Ponta de centrar para aumentar a **precisão** e **reduzir o esforço** com antecedência

Broca robusta com **grande resistência** a quebrar

Fabricada em aço **HSS robusto**

Forjado segundo **DIN 338**

Materiais de fabricação de alta qualidade para garantir **uma maior durabilidade** e **melhor precisão**

Extração ótima de aparas devido à espiral em forma N

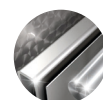

Aço inoxidável

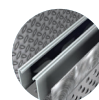

Metal

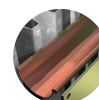

Outros materiais

Devido à liga de cobalto (5% Co), é **altamente resistente ao calor** e adequada para materiais **duros e difíceis**

DIN 338

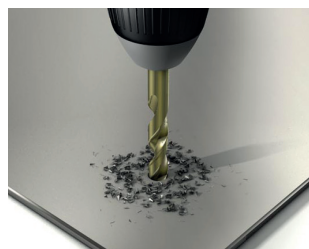

Broca QUATTRIC II

SDS

A broca para **betão armado** de alto rendimento

A ponta de centrar facilita a colocação e evita que a broca deslize

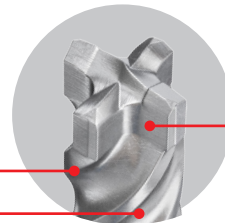

Indicador de desgaste para detetar facilmente o limite de desgaste conforme a PGM

As faces do reforço previnem o prendimento nas armaduras

As bordas de corte aumentam a velocidade de perfuração

Cabeça com desenho **Power Shoulder**, faces de reforço e marcas de utilização

Cabeça de metal de carbono sólido

Núcleo reforçado para uma maior durabilidade

Novo multi-espiral desenhado para trabalhos pesados e para ganhar velocidade

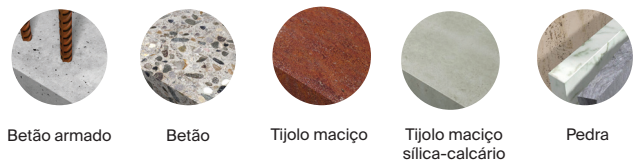

Betão armado

Betão

Tijolo maciço

Tijolo maciço sílica-calcário

Pedra



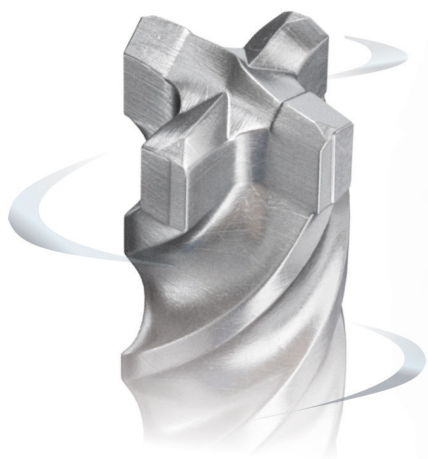

Quattric II

**Mínimo
esforço**

**Máxima
durabilidade**



Broca POINTER SDS

Estabelecendo novos padrões na velocidade de perfuração

A ponta de centrar **facilita a colocação e impede que a broca escorregue**

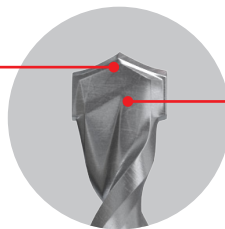

Suas faces de reforço patenteado **reduzem a probabilidade de interferência no armado**

A tecnologia **Power Breakers** cria micro fissuras no material e aumenta a velocidade de perfuração



Extração ideal da poeira **devido à geometria da espiral**

A espiral reforçada do núcleo oferece uma vida útil mais longa



Betão



Tijolo maciço

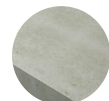

Tijolo maciço sílica-calcário



Pedra



SDS Plus



PGM

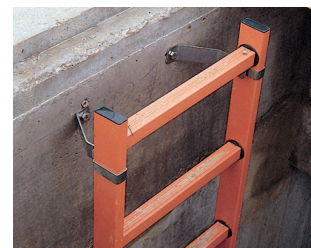
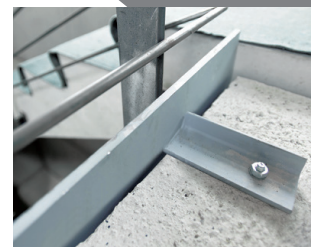

Broca POINTER M SDS

A broca perfeita para **alvenaria**

O filamento de carbono com um ângulo de 130° para **garantir uma maior durabilidade**

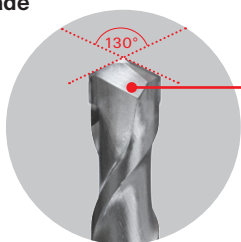

Duas linhas de corte de metal duro para uma **perfuração rápida e segura**

O encavador SDS-Plus encurtado **reduz o impacto da broca e evita possível uso indevido**

A ponta afiada com diamante garante um **avanço de perfuração rápida e segura em diferentes materiais**

A espiral com grande volume garante uma **eliminação perfeita da poeira**



Tijolo oco

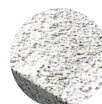

Betão celular

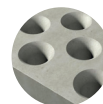

Tijolo maciço sílica-calcário

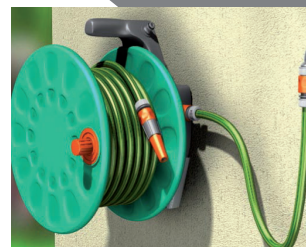

Broca MAX II / MAX IV SDS

As brocas de percussão com **encavador SDS Max**

Certificado PGM garantindo um diâmetro de perfuração

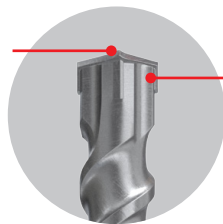

2 pontas em Ø12 y Ø14
4 pontas em Ø superiores

Juntamente com a SDS Max garante uma óptima transmissão de força e permite perfurar, rapidamente, em grande volume

A espiral quádrupla transporta a poeira eficientemente para fora do buraco

O núcleo reforçado assegura uma transmissão máxima de energia e uma redução da vibração

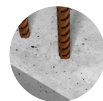

Betão armado

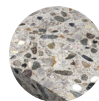

Betão



Tijolo maciço

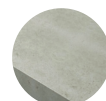

Tijolo maciço sílica-calcário



Pedra

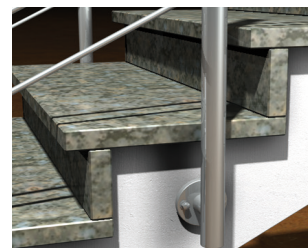
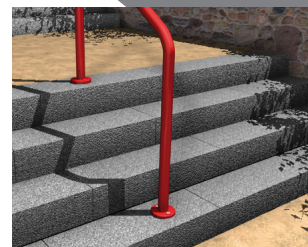

Broca FHD

SDS

Perfuração **sem poeira.**

Ideal para ambientes de **trabalho limpos.**

Garantia na aplicação de **ancoragens certificadas**

Pontas de precisão fabricadas em metal duro para uma **perfuração mais rápida**

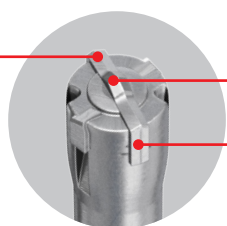

Ponta de centrar que permite **posicionar a broca e evitar desliz**

Marcas de desgaste para identificar o desgaste segundo a certificação **PGM**

Disponível para **SDS Plus** e **SDS Max**

Perfuração e extração da poeira numa única etapa, **economizando muito tempo para a fixação** subsequente



Extração imediata da **poeira** para uma perfuração mais limpa e saudável

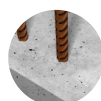

Betão armado

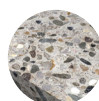

Betão



Tijolo maciço



Tijolo maciço sílica-calcário



Pedra

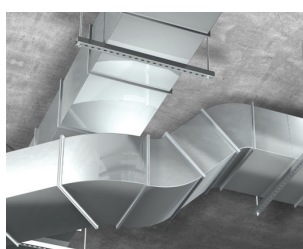
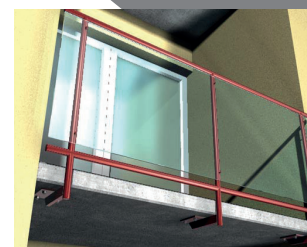

Aspirador FVC 35
para um trabalho impecável

Cinzéis FCP SDS

Cinzéis para um **máximo rendimento** e uma **maior durabilidade**



FCP Flat

Com a sua superfície de trabalho,
garante a sua durabilidade

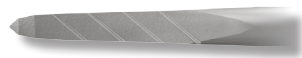

FCP Pointed

Com um desenho auto afiado
garante um alto poder de extração
durante a sua vida útil



FCP Spade

Com uma maior superfície de corte
permite a eliminação de materiais
de grandes volumes



FCP Max Flat

Com uma superfície de trabalho
que assegura a sua durabilidade,
juntamente com encavador
SDS Max



FCP Max Pointed

Com um desenho auto afiado
garante um alto poder de extração
durante a sua vida útil de utilização
juntamente com encavador SDS Max



FCP Max Spade

Com uma maior superfície de corte
que permite a eliminação de materiais
em grandes volumes, juntamente com
encavador SDS Max



Betão



Alvenaria oca

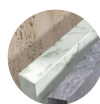

Pedra



SDS Plus



SDS Max



Broca ULTIMATE

Cerâmica

Broca universal com **ponta de carbono**,
ideal para cerâmica

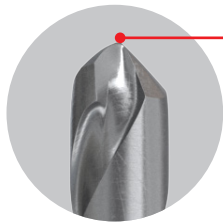

Ponta de carbono
extremamente afiada, ideal
para diversos materiais de
construção

A forma especial da ponta
de carbono **acelera a
perfuração**, o que a torna
adequada para máquinas a
bateria

A soldadura de alta qualidade
garante uma **extrema resistência
na temperatura**

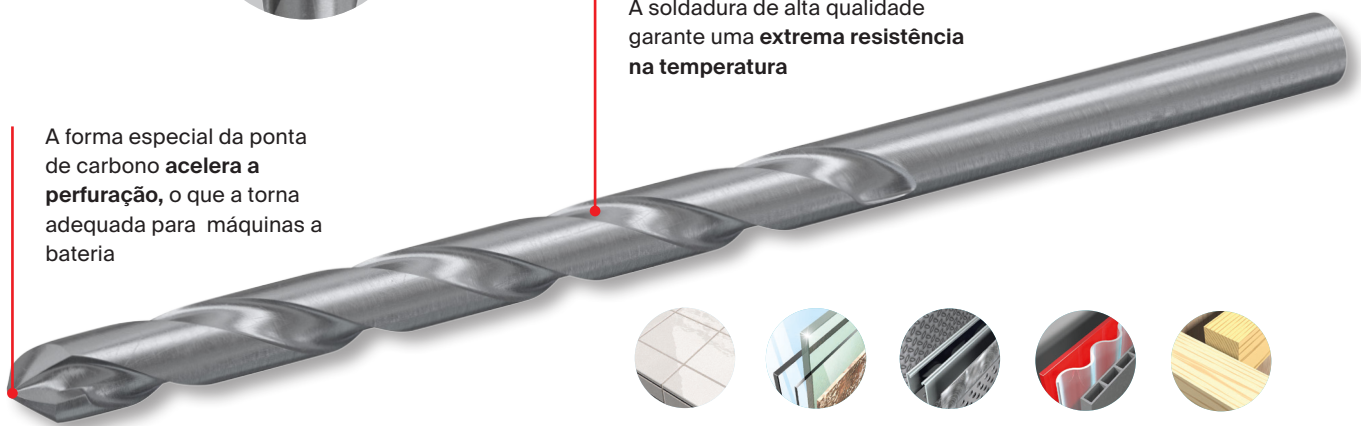

Azulejo

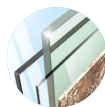

Cristal

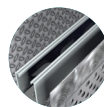

Metal

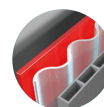

Plástico

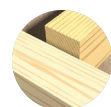

Madeira



Broca D-GT

Cerâmica

Broca de metal duro para vidro e azulejos

A ponta com um ângulo de 120°
permite **perfurar materiais duros**

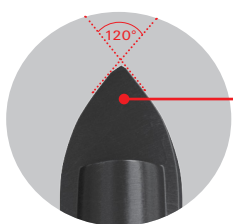

Ponta de centragem
para **maior precisão**

Os melhores resultados de
perfuração são alcançados
em **baixas velocidades** e com
resfriamento suficiente com
água, aguarrás, vinagre ou óleo

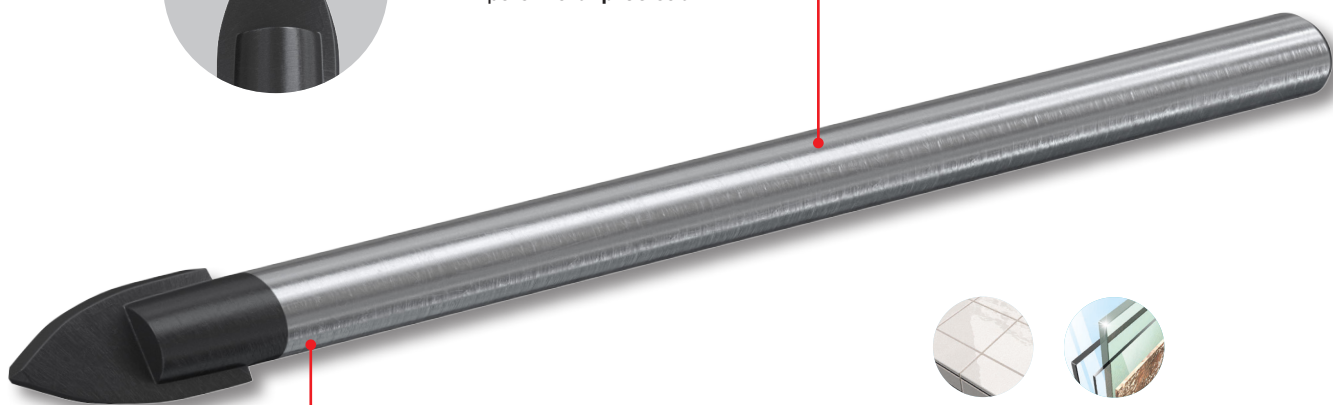

Ponta de carbono para uma
maior durabilidade e uma
melhor resistência
à temperatura



Azulejo

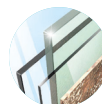

Cristal



Broca DIAMANTE HS-Di

Cerâmica

Broca de **diamante auto refrigerada**
para materiais de construção **extremamente duros**

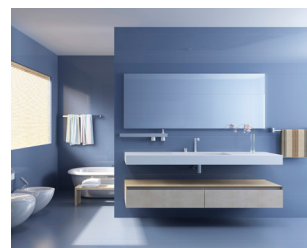
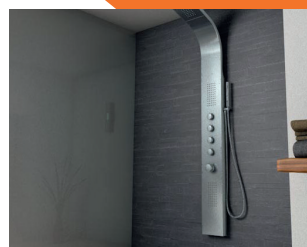
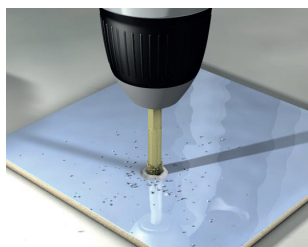

Coroas MULTIMATERIAL HS-Multi

A coroa com **filos de carbono** para diferentes **materiais de construção**

Dentes de metal duro
afiados com diamante
extremamente potente
e duradouro

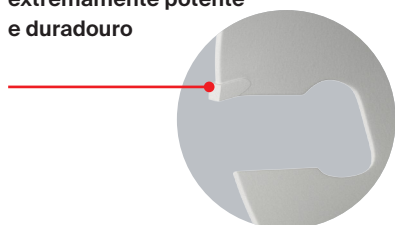

Ranuras em forma de gotas
para remoção de aparas
para um avanço rápido
e ininterrupto da perfuração



Cabeça adaptada para uma
rápida substituição
da coroa após cada
utilização

Ponta de carbono para
uma aplicação universal
com maior durabilidade
e resistência

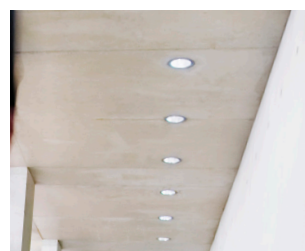
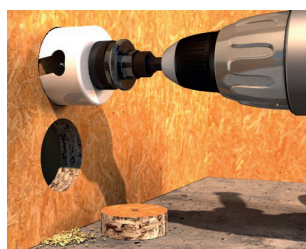

Adaptador com broca de centrar

Ponta de broca de 130° para alta resistência da cabeça

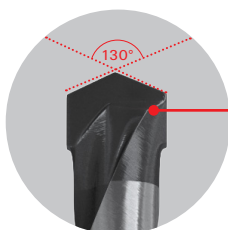

Inclui uma broca centralizadora de 110 mm e uma chave hexagonal

Adaptador com encaixe hexagonal para um bom funcionamento da perfuração

Função "quick change" para fixar com rapidez e segurança e voltar a soltar brocas de centrar e serras craneanas com apenas um clique

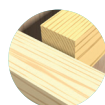
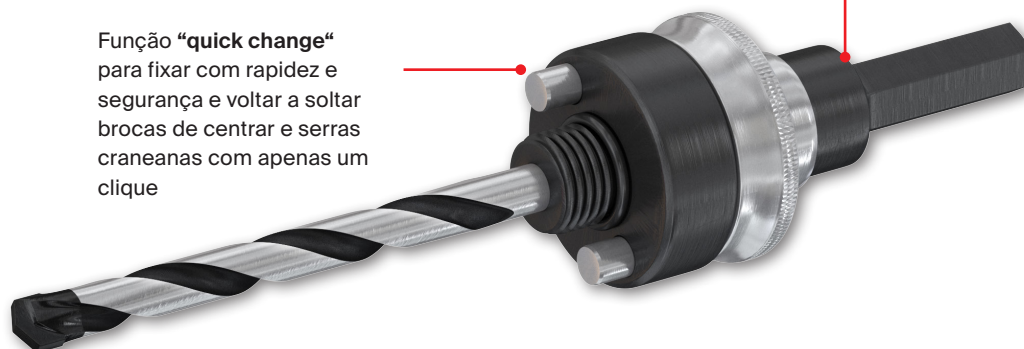

Madeira

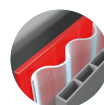

Plástico



Alvenaria oca



Materiais ocos

HM
TCT



Coroa METAL HSS-Co

A coroa com ligas de cobalto para um acabamento perfeito

Dentado progressivo para um efeito de corte poderoso e uma **remoção de aparas acelerada**

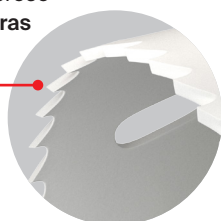

Furos laterais especiais para **uma remoção fácil de núcleos**

Ângulo positivo dos dentes para **evitar vibração**

Rápido furo devido à quantidade de dentes por polegada (entre 4-6)

Bimetal HSS com 8% de liga de cobalto para uma resistência extrema e **uma maior durabilidade e resistência**

Cabeça adaptada para uma **rápida substituição da coroa** após cada utilização

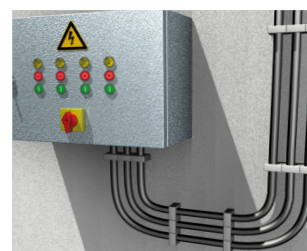
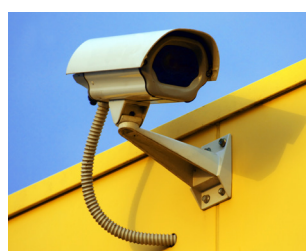

Adaptador com broca de centrar

Ponta da broca de 135° para um rápido furo

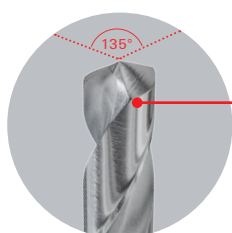

Ponta de centrar para uma otimização na centralização e um alto desempenho

Adaptador com encaixe hexagonal para um bom funcionamento da perfuração

Função "quick change" para fixar com rapidez e segurança e voltar a soltar brocas de centrar e serras craneanas com apenas um clique

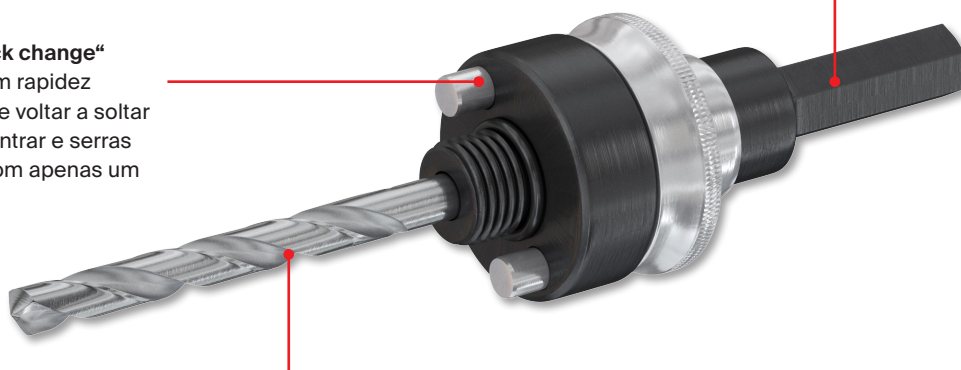

Inclui uma broca centralizadora de 90 mm e uma chave hexagonal

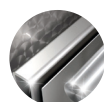

Aço inoxidável

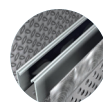

Metal

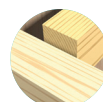

Madeira

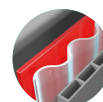

Plástico



STAINLESS



Gama

Percussão

SUPER



Tipo	Art. nº	EAN	Familia	Unidade mínima serviço (packs)	Unidades por pack	Packs por embalagem
BROCA S 3x60	530522	4048962203585	E32	1	2	60
BROCA S 4x75	530523	4048962203592	E32	1	2	60
BROCA S 5x85	530524	4048962203608	E32	1	1	60
BROCA S 6x100	530527	4048962203622	E32	1	1	60
BROCA S 7x100	530552	4048962203790	E32	1	1	60
BROCA S 8x120	530553	4048962203806	E32	1	1	30
BROCA S 9x120	530556	4048962203837	E32	1	1	30
BROCA S 10x120	530557	4048962203844	E32	1	1	30
BROCA S 12x150	530563	4048962203882	E32	1	1	30
BROCA S 14x150	530566	4048962203912	E32	1	1	30
BROCA S 15x150	530568	4048962203936	E32	1	1	30
BROCA S 16x150	530569	4048962203943	E32	1	1	30
BROCA S 18x160	530571	4048962203967	E32	1	1	18
BROCA S 20x160	530573	4048962203981	E32	1	1	18
BROCA BL-S 5x150	530525	4048962203615	E32	1	1	1
BROCA BL-S 6x150	530528	4048962203639	E32	1	1	1
BROCA BL-S 8x200	530554	4048962203813	E32	1	1	1
BROCA BL-S 8x400	530555	4048962203820	E32	1	1	1
BROCA BL-S 10x200	530558	4048962203851	E32	1	1	1
BROCA BL-S 10x400	530559	4048962203868	E32	1	1	1
BROCA BL-S 12x200	530564	4048962203899	E32	1	1	1
BROCA BL-S 12x400	530565	4048962203905	E32	1	1	1
BROCA BL-S 14x400	530567	4048962203929	E32	1	1	1
BROCA BL-S 16x400	530570	4048962203950	E32	1	1	1
BROCA BL-S 18x400	530572	4048962203974	E32	1	1	1
BROCA BL-S 20x400	530574	4048962203998	E32	1	1	18



Tipo	Art. nº	EAN	Familia	Unidade mínima serviço (packs)	Unidades por pack	Packs por embalagem
KIT BROCAS S (5 UDS)	543025	4048962301861	E32	1	1	1
KIT BROCAS S (8 UDS)	543027	4048962301885	E32	1	1	1
KIT BROCAS E (5 UDS)	536606	4048962249293	E32	1	1	1
KIT BROCAS E (8 UDS)	536607	4048962249309	E32	1	1	1

*KIT 5 BROCAS (Ø4-5-6-8-10) / KIT 8 BROCAS (Ø3-4-5-6-7-8-9-10)

Percussão

EXTRA



Tipo	Art. nº	EAN	Família	Unidade mínima serviço (packs)	Unidades por pack	Packs por embalagem
BROCA E 3x60	530575	4048962204001	E32	1	2	60
BROCA E 4x75	530576	4048962204018	E32	1	2	60
BROCA E 5x85	530577	4048962204025	E32	1	1	60
BROCA E 6x100	530579	4048962204049	E32	1	1	60
BROCA E 7x100	530584	4048962204063	E32	1	1	60
BROCA E 8x120	530590	4048962204070	E32	1	1	30
BROCA E 9x120	530592	4048962204094	E32	1	1	30
BROCA E 10x120	530593	4048962204100	E32	1	1	30
BROCA E 11x150	530596	4048962204124	E32	1	1	30
BROCA E 12x150	530597	4048962204131	E32	1	1	30
BROCA E 14x150	530601	4048962204155	E32	1	1	30
BROCA E 16x150	530604	4048962204162	E32	1	1	30
BROCA E 20x160	530607	4048962204186	E32	1	1	18
BROCA BL-E 6x400	530580	4048962204056	E32	1	1	1
BROCA BL-E 8x400	530591	4048962204087	E32	1	1	1
BROCA BL-E 10x400	530595	4048962204117	E32	1	1	1
BROCA BL-E 12x400	530600	4048962204148	E32	1	1	1

Percussão

QUATRIUM



Tipo	Art. nº	EAN	Família	Unidade mínima serviço (packs)	Unidades por pack	Packs por embalagem
BROCA D-SDX 5,0x44/85	545049	4048962320176	E32	1	1	60
BROCA D-SDX 6,0x60/100	545051	4048962320183	E32	1	1	60
BROCA D-SDX 8,0x70/120	545052	4048962320190	E32	1	1	30
BROCA D-SDX 10,0x70/120	545053	4048962320206	E32	1	1	30
BROCA D-SDX 12,0x90/150	545054	4048962320213	E32	1	1	30

Gama

Madeira

HB



Tipo	Art. nº	EAN	Familia	Unidad mínima servicio (packs)	Unidades por pack	Packs por embalagem
BROCA HB 3	530630	4048962204360	E34	1	2	60
BROCA HB 4	530634	4048962204377	E34	1	2	60
BROCA HB 5	530635	4048962204384	E34	1	1	60
BROCA HB 6	530636	4048962204391	E34	1	1	60
BROCA HB 8	530638	4048962204407	E34	1	1	30
BROCA HB 10	530639	4048962204414	E34	1	1	30
BROCA HB 12	530640	4048962204421	E34	1	1	30

Madeira

PALA



Tipo	Art. nº	EAN	Familia	Unidad mínima servicio (packs)	Unidades por pack	Packs por embalagem
BROCA PALA MADEIRA 12MM	530647	4048962204438	E34	1	1	30
BROCA PALA MADEIRA 14MM	530650	4048962204445	E34	1	1	30
BROCA PALA MADEIRA 16MM	530655	4048962204469	E34	1	1	30
BROCA PALA MADEIRA 18MM	530656	4048962204476	E34	1	1	30
BROCA PALA MADEIRA 20MM	530657	4048962204483	E34	1	1	30
BROCA PALA MADEIRA 22MM	530658	4048962204490	E34	1	1	30
BROCA PALA MADEIRA 24MM	530659	4048962204506	E34	1	1	30
BROCA PALA MADEIRA 25MM	530660	4048962204513	E34	1	1	30
BROCA PALA MADEIRA 26MM	530661	4048962204520	E34	1	1	30
BROCA PALA MADEIRA 28MM	530663	4048962204544	E34	1	1	30
BROCA PALA MADEIRA 30MM	530665	4048962204551	E34	1	1	30

Metal

HSS



Tipo	Art. nº	EAN	Família	Unidade mínima serviço (packs)	Unidades por pack	Packs por embalagem
BROCA HSS-R DIN338 1x12/34	530403	4048962202816	E37	1	2	60
BROCA HSS-R DIN338 1,5x18/40	530404	4048962202823	E37	1	2	60
BROCA HSS-R DIN338 2x24/49	530405	4048962202830	E37	1	2	60
BROCA HSS-R DIN338 2,5x30/57	530406	4048962202847	E37	1	2	60
BROCA HSS-R DIN338 3x33/61	530407	4048962202854	E37	1	2	60
BROCA HSS-R DIN338 3,2x36/65	530408	4048962202861	E37	1	2	60
BROCA HSS-R DIN338 3,5x39/70	530409	4048962202878	E37	1	2	60
BROCA HSS-R DIN338 4x43/75	530410	4048962202885	E37	1	2	60
BROCA HSS-R DIN338 4,2x43/75	530411	4048962202892	E37	1	1	60
BROCA HSS-R DIN338 4,5x47/80	530412	4048962202908	E37	1	1	60
BROCA HSS-R DIN338 5x52/86	530413	4048962202915	E37	1	1	60
BROCA HSS-R DIN338 5,5x57/93	530415	4048962202939	E37	1	1	60
BROCA HSS-R DIN338 6x57/93	530416	4048962202946	E37	1	1	60
BROCA HSS-R DIN338 6,5x63/101	530417	4048962202953	E37	1	1	60
BROCA HSS-R DIN338 7x69/109	530418	4048962202960	E37	1	1	30
BROCA HSS-R DIN338 8x75/117	530483	4048962203233	E37	1	1	30
BROCA HSS-R DIN338 8,5x75/117	530484	4048962203240	E37	1	1	30
BROCA HSS-R DIN338 9x81/125	530485	4048962203257	E37	1	1	30
BROCA HSS-R DIN338 10x87/133	530487	4048962203271	E37	1	1	30
BROCA HSS-R DIN338 11x94/142	530488	4048962203288	E37	1	1	30
BROCA HSS-R DIN338 12x101/151	530489	4048962203295	E37	1	1	30
BROCA HSS-R DIN338 13x101/151	530490	4048962203301	E37	1	1	30
BROCA HSS-R DIN338 2,0x24/49	543083	4048962302387	E37	1	1	10
BROCA HSS-R DIN338 2,5x30/57	543088	4048962302431	E37	1	1	10
BROCA HSS-R DIN338 3,0x33/61	543093	4048962302486	E37	1	1	10
BROCA HSS-R DIN338 3,5x39/70	543098	4048962302530	E37	1	1	10
BROCA HSS-R DIN338 4,0x43/75	543103	4048962302585	E37	1	1	10
BROCA HSS-R DIN338 4,5x47/80	543108	4048962302639	E37	1	1	10
BROCA HSS-R DIN338 5,0x52/86	543113	4048962302684	E37	1	1	10
BROCA HSS-R DIN338 6,0x57/93	543123	4048962302783	E37	1	1	10
BROCA HSS-R DIN338 7,0x69/109	543133	4048962302882	E37	1	1	10
BROCA HSS-R DIN338 8,0x75/117	543143	4048962302981	E37	1	1	5

Gama

Metal HSS-Co



Tipo	Art. nº	EAN	Família	Unidade mínima serviço (packs)	Unidades por pack	Packs por embalagem
BROCA HSS-Co DIN338 1x12/34	530491	4048962203318	E37	1	2	60
BROCA HSS-Co DIN338 1,5x18/40	530492	4048962203325	E37	1	2	60
BROCA HSS-Co DIN338 2x24/49	530493	4048962203332	E37	1	2	60
BROCA HSS-Co DIN338 2,5x30/57	530494	4048962203349	E37	1	2	60
BROCA HSS-Co DIN338 3x33/61	530495	4048962203356	E37	1	2	60
BROCA HSS-Co DIN338 3,2x36/65	530496	4048962203363	E37	1	2	60
BROCA HSS-Co DIN338 3,5x39/70	530497	4048962203370	E37	1	2	60
BROCA HSS-Co DIN338 4x43/75	530498	4048962203387	E37	1	2	60
BROCA HSS-Co DIN338 4,2x43/75	530499	4048962203394	E37	1	1	60
BROCA HSS-Co DIN338 4,5x47/80	530504	4048962203400	E37	1	1	60
BROCA HSS-Co DIN338 5x52/86	530505	4048962203417	E37	1	1	60
BROCA HSS-Co DIN338 5,5x57/93	530506	4048962203424	E37	1	1	60
BROCA HSS-Co DIN338 6x57/93	530507	4048962203431	E37	1	1	60
BROCA HSS-Co DIN338 6,5x63/101	530508	4048962203448	E37	1	1	60
BROCA HSS-Co DIN338 7x69/109	530509	4048962203455	E37	1	1	30
BROCA HSS-Co DIN338 7,5x69/109	530510	4048962203462	E37	1	1	30
BROCA HSS-Co DIN338 8x75/117	530511	4048962203479	E37	1	1	30
BROCA HSS-Co DIN338 8,5x75/117	530512	4048962203486	E37	1	1	30
BROCA HSS-Co DIN338 9x81/125	530513	4048962203493	E37	1	1	30
BROCA HSS-Co DIN338 10x87/133	530515	4048962203516	E37	1	1	30
BROCA HSS-Co DIN338 11x94/142	530517	4048962203530	E37	1	1	30
BROCA HSS-Co DIN338 12x101/151	530519	4048962203554	E37	1	1	30
BROCA HSS-Co DIN338 13x101/151	530521	4048962203578	E37	1	1	30
BROCA HSS-Co DIN338 1,5x18/40	543185	4048962303407	E37	1	1	10
BROCA HSS-Co DIN338 2,0x24/49	543190	4048962303452	E37	1	1	10
BROCA HSS-Co DIN338 2,5x30/57	543195	4048962303506	E37	1	1	10
BROCA HSS-Co DIN338 3,0x33/61	543200	4048962303551	E37	1	1	10
BROCA HSS-Co DIN338 3,2x36/65	543202	4048962303575	E37	1	1	10
BROCA HSS-Co DIN338 3,5x39/70	543205	4048962303605	E37	1	1	10
BROCA HSS-Co DIN338 4,0x43/75	543210	4048962303650	E37	1	1	10
BROCA HSS-Co DIN338 4,2x43/75	543212	4048962303674	E37	1	1	10
BROCA HSS-Co DIN338 4,5x47/80	543215	4048962303704	E37	1	1	10
BROCA HSS-Co DIN338 5,0x52/86	543220	4048962303759	E37	1	1	10
BROCA HSS-Co DIN338 5,5x57/93	543225	4048962303803	E37	1	1	10
BROCA HSS-Co DIN338 6,0x57/93	543230	4048962303858	E37	1	1	10
BROCA HSS-Co DIN338 6,5x63/101	543235	4048962303902	E37	1	1	10
BROCA HSS-Co DIN338 7,0x69/109	543240	4048962303957	E37	1	1	10
BROCA HSS-Co DIN338 8,0x75/117	543250	4048962304053	E37	1	1	5
BROCA HSS-Co DIN338 8,5x75/117	543255	4048962304107	E37	1	1	5
BROCA HSS-Co DIN338 9,0x81/125	543260	4048962304152	E37	1	1	5
BROCA HSS-Co DIN338 9,5x81/125	543265	4048962304206	E37	1	1	5
BROCA HSS-Co DIN338 10,0x87/133	543270	4048962304251	E37	1	1	5
BROCA HSS-Co DIN338 10,5x94/142	543272	4048962304275	E37	1	1	5
BROCA HSS-Co DIN338 11,0x94/142	543273	4048962304282	E37	1	1	5
BROCA HSS-Co DIN338 12,0x101/151	543275	4048962304305	E37	1	1	5
BROCA HSS-Co DIN338 13,0x101/151	543277	4048962304329	E37	1	1	5

SDS QUATTRIC II



Tipo	Art. nº	EAN	Família	Unidade mínima serviço (packs)	Unidades por pack	Packs por embalagem
SDS Plus QUATTRIC II 5/50/115	549973	4048962307092	E33	1	1	5
SDS Plus QUATTRIC II 5/100/165	549974	4048962307108	E33	1	1	5
SDS Plus QUATTRIC II 6/50/115	549983	4048962307191	E33	1	1	5
SDS Plus QUATTRIC II 6/100/165	549979	4048962307153	E33	1	1	5
SDS Plus QUATTRIC II 6/100/165	549980	4048962307160	E33	1	1	10
SDS Plus QUATTRIC II 6/150/215	549981	4048962307177	E33	1	1	5
SDS Plus QUATTRIC II 6,5/150/215	549976	4048962307122	E33	1	1	5
SDS Plus QUATTRIC II 7/100/165	549987	4048962307238	E33	1	1	5
SDS Plus QUATTRIC II 8/50/115	549993	4048962307290	E33	1	1	5
SDS Plus QUATTRIC II 8/100/165	549988	4048962307245	E33	1	1	5
SDS Plus QUATTRIC II 8/150/215	549990	4048962307269	E33	1	1	5
SDS Plus QUATTRIC II 8/150/215	549991	4048962307276	E33	1	1	5
SDS Plus QUATTRIC II 8/250/315	549992	4048962307283	E33	1	1	5
SDS Plus QUATTRIC II 10/50/115	549928	4048962306651	E33	1	1	5
SDS Plus QUATTRIC II 10/100/165	549922	4048962306590	E33	1	1	5
SDS Plus QUATTRIC II 10/100/165	549923	4048962306606	E33	1	1	10
SDS Plus QUATTRIC II 10/100/165	549924	4048962306613	E33	1	1	5
SDS Plus QUATTRIC II 10/150/215	549925	4048962306620	E33	1	1	5
SDS Plus QUATTRIC II 10/150/215	549926	4048962306637	E33	1	1	5
SDS Plus QUATTRIC II 10/250/315	549927	4048962306644	E33	1	1	5
SDS Plus QUATTRIC II 12/100/160	549932	4048962306699	E33	1	1	5
SDS Plus QUATTRIC II 12/110/160	549933	4048962306705	E33	1	1	5
SDS Plus QUATTRIC II 12/160/210	549936	4048962306736	E33	1	1	5
SDS Plus QUATTRIC II 12/160/210	549937	4048962306743	E33	1	1	5
SDS Plus QUATTRIC II 12/210/260	549938	4048962306750	E33	1	1	5
SDS Plus QUATTRIC II 12/260/310	549939	4048962306767	E33	1	1	5
SDS Plus QUATTRIC II 14/100/160	549941	4048962306781	E33	1	1	5
SDS Plus QUATTRIC II 14/160/210	549944	4048962306811	E33	1	1	5
SDS Plus QUATTRIC II 14/260/310	549945	4048962306828	E33	1	1	5
SDS Plus QUATTRIC II 14/400/450	549943	4048962306804	E33	1	1	5
SDS Plus QUATTRIC II 15/160/210	549947	4042205355314	E33	1	1	5
SDS Plus QUATTRIC II 16/110/160	549950	4048962306866	E33	1	1	5
SDS Plus QUATTRIC II 16/160/210	549951	4048962306873	E33	1	1	5
SDS Plus QUATTRIC II 16/260/310	549953	4048962306897	E33	1	1	5
SDS Plus QUATTRIC II 18/200/250	549956	4048962306927	E33	1	1	5
SDS Plus QUATTRIC II 18/400/450	549957	4048962306934	E33	1	1	5
SDS Plus QUATTRIC II 20/400/450	549959	4048962306958	E33	1	1	5
SDS Plus QUATTRIC II 22/400/450	549961	4048962306972	E33	1	1	5
SDS Plus QUATTRIC II 24/400/450	549963	4048962306996	E33	1	1	5
SDS Plus QUATTRIC II 25/400/450	549965	4048962307016	E33	1	1	5
SDS Plus QUATTRIC II 28/400/450	549967	4048962307030	E33	1	1	5
SDS Plus QUATTRIC II 30/400/450	549969	4048962307054	E33	1	1	5
SDS Plus QUATTRIC II 32/400/450	549970	4048962307061	E33	1	1	5

Gama

SDS

POINTER



Tipo	Art. nº	EAN	Família	Unidade mínima serviço (packs)	Unidades por pack	Packs por embalagem
SDS Plus II V POINTER 4/50/110	531753	4048962211757	E33	1	1	5
SDS Plus II V POINTER 5/50/110	531755	4048962211771	E33	1	1	5
SDS Plus II V POINTER 5/100/160	531756	4048962211788	E33	1	1	5
SDS Plus II V POINTER 5/150/210	531757	4048962211795	E33	1	1	5
SDS Plus II V POINTER 5,5/150/210	531762	4048962211849	E33	1	1	5
SDS Plus II V POINTER 6/50/110	531765	4048962211870	E33	1	1	5
SDS Plus II V POINTER 6/100/160	531766	4048962211887	E33	1	1	5
SDS Plus II V POINTER 6/150/210	531767	4048962211894	E33	1	1	5
SDS Plus II V POINTER 6/200/260	531768	4048962211900	E33	1	1	5
SDS Plus II V POINTER 6,5/200/260	531773	4042205306804	E33	1	1	5
SDS Plus II V POINTER 7/150/210	531777	4048962211993	E33	1	1	5
SDS Plus II V POINTER 8/50/110	531779	4048962212013	E33	1	1	5
SDS Plus II V POINTER 8/100/160	531780	4048962212020	E33	1	1	5
SDS Plus II V POINTER 8/150/210	531781	4048962212037	E33	1	1	5
SDS Plus II V POINTER 8/200/260	531782	4048962212044	E33	1	1	5
SDS Plus II V POINTER 8/400/460	531785	4048962212075	E33	1	1	5
SDS Plus II V POINTER 9/150/210	531789	4048962212112	E33	1	1	5
SDS Plus II V POINTER 10/50/110	531791	4048962212136	E33	1	1	5
SDS Plus II V POINTER 10/100/160	531792	4048962212143	E33	1	1	5
SDS Plus II V POINTER 10/150/210	531793	4048962212150	E33	1	1	5
SDS Plus II V POINTER 10/200/260	531794	4048962212167	E33	1	1	5
SDS Plus II V POINTER 10/250/310	531795	4048962212174	E33	1	1	5
SDS Plus II V POINTER 10/400/450	531797	4048962212198	E33	1	1	5
SDS Plus II V POINTER 11/250/310	531802	4048962212242	E33	1	1	5
SDS Plus II V POINTER 12/100/160	531803	4048962212259	E33	1	1	5
SDS Plus II V POINTER 12/150/210	531804	4048962212266	E33	1	1	5
SDS Plus II V POINTER 12/200/260	531805	4048962212273	E33	1	1	5
SDS Plus II V POINTER 12/400/450	531808	4048962212303	E33	1	1	5
SDS Plus II V POINTER 13/210/260	531813	4048962212358	E33	1	1	5
SDS Plus II V POINTER 14/100/160	531815	4048962212372	E33	1	1	5
SDS Plus II V POINTER 14/150/210	531816	4048962212389	E33	1	1	5
SDS Plus II V POINTER 14/200/260	531817	4048962212396	E33	1	1	5
SDS Plus II V POINTER 14/400/450	531819	4048962212419	E33	1	1	5
SDS Plus II V POINTER 15/200/260	531824	4048962212464	E33	1	1	5
SDS Plus II V POINTER 16/150/210	531827	4048962212495	E33	1	1	5
SDS Plus II V POINTER 16/250/310	531829	4048962212518	E33	1	1	5
SDS Plus II V POINTER 16/400/450	531830	4048962212525	E33	1	1	5
SDS Plus II V POINTER 18/150/200	531836	4048962212587	E33	1	1	5
SDS Plus II V POINTER 18/400/450	531838	4048962212600	E33	1	1	5
SDS Plus II V POINTER 20/400/450	531845	4048962212679	E33	1	1	5
SDS Plus II V POINTER 22/400/450	531850	4048962212716	E33	1	1	5
SDS Plus II V POINTER 24/400/450	531854	4048962212754	E33	1	1	5
SDS Plus II V POINTER 25/400/450	531856	4048962212778	E33	1	1	5
SDS Plus II V POINTER 26/400/450	531859	4048962212808	E33	1	1	5

SDS POINTER M



Tipo	Art. nº	EAN	Família	Unidade mínima serviço (packs)	Unidades por pack	Packs por embalagem
SDS Short POINTER M 6/350/410	546204	4048962327526	E33	1	1	1
SDS Short POINTER M 8/200/260	544382	4048962314045	E33	1	1	1
SDS Short POINTER M 10/200/260	543630	4048962308716	E33	1	1	1
SDS Short POINTER M 12/200/260	543631	4048962308723	E33	1	1	1
SDS Short POINTER M 14/200/260	543632	4048962308730	E33	1	1	1
SDS Short POINTER M 16/200/260	543633	4048962308747	E33	1	1	1
SDS Short POINTER M 16/100/400	543634	4048962308754	E33	1	1	1
SDS Short POINTER M 18/350/410	546205	4048962327533	E33	1	1	1
SDS Short POINTER M 20/100/400	543635	4048962308761	E33	1	1	1
SDS Short POINTER M 22/350/410	546206	4048962327540	E33	1	1	1



Gama

SDS

MAX II / MAX IV



Tipo	Art. nº	EAN	Familia	Unidade mínima serviço (packs)	Unidades por pack	Packs por embalagem
SDS MAX II 12/400/540	504189	4048962061505	E33	1	1	1
SDS MAX II 14/200/340	504192	4048962061529	E33	1	1	1
SDS MAX II 14/400/540	504194	4048962061536	E33	1	1	1
SDS MAX IV 16/200/340	504198	4048962061567	E33	1	1	1
SDS MAX IV 16/400/540	504199	4048962061574	E33	1	1	1
SDS MAX IV 16/800/920	504200	4048962061581	E33	1	1	1
SDS MAX IV 16/1200/1320	504206	4048962061598	E33	1	1	1
SDS MAX IV 18/200/340	504207	4048962061604	E33	1	1	1
SDS MAX IV 18/400/540	504208	4048962061611	E33	1	1	1
SDS MAX IV 20/200/320	504214	4048962061642	E33	1	1	1
SDS MAX IV 20/400/520	504217	4048962061659	E33	1	1	1
SDS MAX IV 20/800/920	504222	4048962061666	E33	1	1	1
SDS MAX IV 22/200/320	504224	4048962061680	E33	1	1	1
SDS MAX IV 22/400/520	504225	4048962061697	E33	1	1	1
SDS MAX IV 22/800/920	504226	4048962061703	E33	1	1	1
SDS MAX IV 24/200/320	504228	4048962061727	E33	1	1	1
SDS MAX IV 24/400/520	504229	4048962061734	E33	1	1	1
SDS MAX IV 25/200/320	504235	4048962061741	E33	1	1	1
SDS MAX IV 25/400/520	504236	4048962061758	E33	1	1	1
SDS MAX IV 25/800/920	504237	4048962061765	E33	1	1	1
SDS MAX IV 25/1200/1320	504238	4048962061772	E33	1	1	1
SDS MAX IV 28/250/370	504240	4048962061796	E33	1	1	1
SDS MAX IV 28/550/670	504242	4048962061819	E33	1	1	1
SDS MAX IV 30/250/370	504245	4048962061840	E33	1	1	1
SDS MAX IV 32/800/920	504249	4048962061888	E33	1	1	1
SDS MAX IV 32/1200/1320	504250	4048962061895	E33	1	1	1
SDS MAX IV 35/450/570	504256	4048962061918	E33	1	1	1
SDS MAX IV 35/550/670	504257	4048962061925	E33	1	1	1
SDS MAX IV 37/450/570	504265	4048962061963	E33	1	1	1
SDS MAX IV 40/450/570	504270	4048962062014	E33	1	1	1
SDS MAX IV 45/450/570	504274	4048962062045	E33	1	1	1
SDS MAX IV 52/450/570	504276	4048962062069	E33	1	1	1

SDS

FHD



Tipo	Art. nº	EAN	Família	Unidade mínima serviço (packs)	Unidades por pack	Packs por embalagem
FHD 12/200/330	546597	4048962330823	E33	1	1	1
FHD 14/250/380	546598	4048962330830	E33	1	1	1
FHD 16/250/380	546599	4048962330847	E33	1	1	1
FHD 18/320/450	546600	4048962330854	E33	1	1	1
FHD MAX 16/400/620	546601	4048962330861	E33	1	1	1
FHD MAX 18/400/620	546602	4048962330878	E33	1	1	1
FHD MAX 20/400/621	546603	4048962330885	E33	1	1	1
FHD MAX 24/400/621	546604	4048962330892	E33	1	1	1
FHD MAX 28/600/820	546605	4048962330908	E33	1	1	1
FHD MAX 30/600/820	546606	4048962330915	E33	1	1	1
FHD MAX 35/650/870	546607	4048962330922	E33	1	1	1
ASPIRADOR FVC 35 M	551924	4048962355680	E33	1	1	1

SDS

CINZÉIS FCP

FCP Flat 

FCP Max Flat 

FCP Pointed 

FCP Max Pointed 

FCP Spade 

FCP Max Spade 

Tipo	Art. nº	EAN	Família	Unidade mínima serviço (packs)	Unidades por pack	Packs por embalagem
FCP Flat 20/250	546315	4048962329001	E33	1	1	1
FCP Max Flat 25/400	546318	4048962329032	E33	1	1	1
FCP Pointed 250	546314	4048962328998	E33	1	1	1
FCP Max Pointed 400	546317	4048962329025	E33	1	1	1
FCP Spade 40/250	546316	4048962329018	E33	1	1	1
FCP Max Spade 50/380	546319	4048962329049	E33	1	1	1
FCP Set	546320	4048962329056	E33	1	1	1
FCP Max Set	546321	4048962329063	E33	1	1	1

Gama

Cerâmica

ULTIMATE



Tipo	Art. nº	EAN	Família	Unidade mínima serviço (packs)	Unidades por pack	Packs por embalagem
ULTIMATE DRILL 5x85	530623	4048962204292	E32	1	1	60
ULTIMATE DRILL 6x100	530624	4048962204308	E32	1	1	60
ULTIMATE DRILL 8x125	530626	4048962204322	E32	1	1	30

Cerâmica

D-GT



Tipo	Art. nº	EAN	Família	Unidade mínima serviço (packs)	Unidades por pack	Packs por embalagem
D-GT 4,0x10/60	551342	4042205342017	E33	1	1	1
D-GT 5,0x11/70	551340	4042205342031	E33	1	1	1
D-GT 6,0x13/75	551341	4042205342024	E33	1	1	1
D-GT 8,0x14/80	551343	4042205342000	E33	1	1	1
D-GT 10,0x15/100	551344	4042205341997	E33	1	1	1

Cerâmica

DIAMANTE



Tipo	Art. nº	EAN	Família	Unidade mínima serviço (packs)	Unidades por pack	Packs por embalagem
HS-Di 5,0	551345	4048962287035	E26	1	1	15
HS-Di 6,0	551346	4048962287042	E26	1	1	15
HS-Di 8,0	551347	4048962287059	E26	1	1	15
HS-Di 10,0	551348	4048962287066	E26	1	1	15
HS-Di 12,0	551349	4048962287073	E26	1	1	15
HS-Di 14,0	551350	4048962287080	E26	1	1	15

Coroas

MULTIMATERIAL

Tipo	Art. nº	EAN	Família	Unidade mínima serviço (packs)	Unidades por pack	Packs por embalagem
HS-Multi 20,0	551351	4048962287097	E26	1	1	30
HS-Multi 25,0	551353	4048962287103	E26	1	1	30
HS-Multi 30,0	551354	4048962287110	E26	1	1	15
HS-Multi 35,0	551358	4048962287127	E26	1	1	15
HS-Multi 40,0	551360	4048962287134	E26	1	1	15
HS-Multi 51,0	551361	4048962287141	E26	1	1	10
HS-Multi 60,0	551362	4048962287158	E26	1	1	5
HS-Multi 68,0	551363	4048962287165	E26	1	1	5
HS-Multi 83,0	551364	4048962287172	E26	1	1	5
HS-Multi 89,0	551365	4048962287189	E26	1	1	5
HS-Multi 102,0	551366	4048962287196	E26	1	1	5
Adaptador HS-Multi A1S (até ø30)	551367	4048962287202	E26	1	1	15
Adaptador HS-Multi A2S (ø30-ø102)	551368	4048962287219	E26	1	1	10
Ponta de centrar (para tijolo)	551369	4048962287226	E26	1	1	25
Ponta de centrar (para madeira)	551370	4048962287233	E26	1	1	25
Extensor Coroa 300mm	553385	4048962365573	E26	1	1	10

Coroas

METAL



Tipo	Art. nº	EAN	Família	Unidade mínima serviço (packs)	Unidades por pack	Packs por embalagem
HS-HSS-Co 20,0	532001	4048962213836	E26	1	1	30
HS-HSS-Co 25,0	532007	4048962213904	E26	1	1	30
HS-HSS-Co 30,0	532012	4048962213959	E26	1	1	15
HS-HSS-Co 35,0	532016	4048962213997	E26	1	1	15
HS-HSS-Co 40,0	532019	4048962214024	E26	1	1	15
HS-HSS-Co 51,0	532025	4048962214086	E26	1	1	7
HS-HSS-Co 60,0	532032	4048962214130	E26	1	1	7
HS-HSS-Co 68,0	532036	4048962214178	E26	1	1	7
HS-HSS-Co 83,0	532044	4048962214246	E26	1	1	7
HS-HSS-Co 102,0	532054	4048962214314	E26	1	1	7
Adaptador HS-HSS-Co A1 (até ø30)	532057	4048962214345	E26	1	1	15
Adaptador HS-HSS-Co A2 (ø30-ø102)	532058	4048962214352	E26	1	1	10
Ponta de centrar (para metal)	532061	4048962214369	E26	1	1	25

Revendedor:

www.fischer.de



FIXING SYSTEMS
AUTOMOTIVE SYSTEMS
FISCHERTECHNIK
CONSULTING
LNT AUTOMATION

fischerwerke Portugal, Lda.
Rua das Musas,
Passeio dos Cruzados,
Loja 8
1990-171 Lisboa
Portugal
Tel. +351 218 954 180
www.fischer.pt
fischerportugal.info@fischer.pt
